

DP-FLOW

email: sales@dp-flow.co.uk
sales +44(0)1608 544222

SIEMENS

PROCESS INSTRUMENTATION

Battery-powered,
**reliable and cost
efficient.**



Start now

The water meter of choice for distribution, billing and irrigation

The SITRANS FM MAG 8000 portfolio of battery-operated flowmeters combines world-class performance with a low cost of ownership, tailored to meet the needs of your specific water application. No mains power required.

Few resources are as vital to the human population, the environment and the global economy as water. To ensure the continuous preservation of this valuable commodity, the water industry has come to rely on the versatile SITRANS FM MAG 8000 program of battery-operated electromagnetic flowmeters from Siemens for such varied tasks as water distribution, revenue metering and crop irrigation.

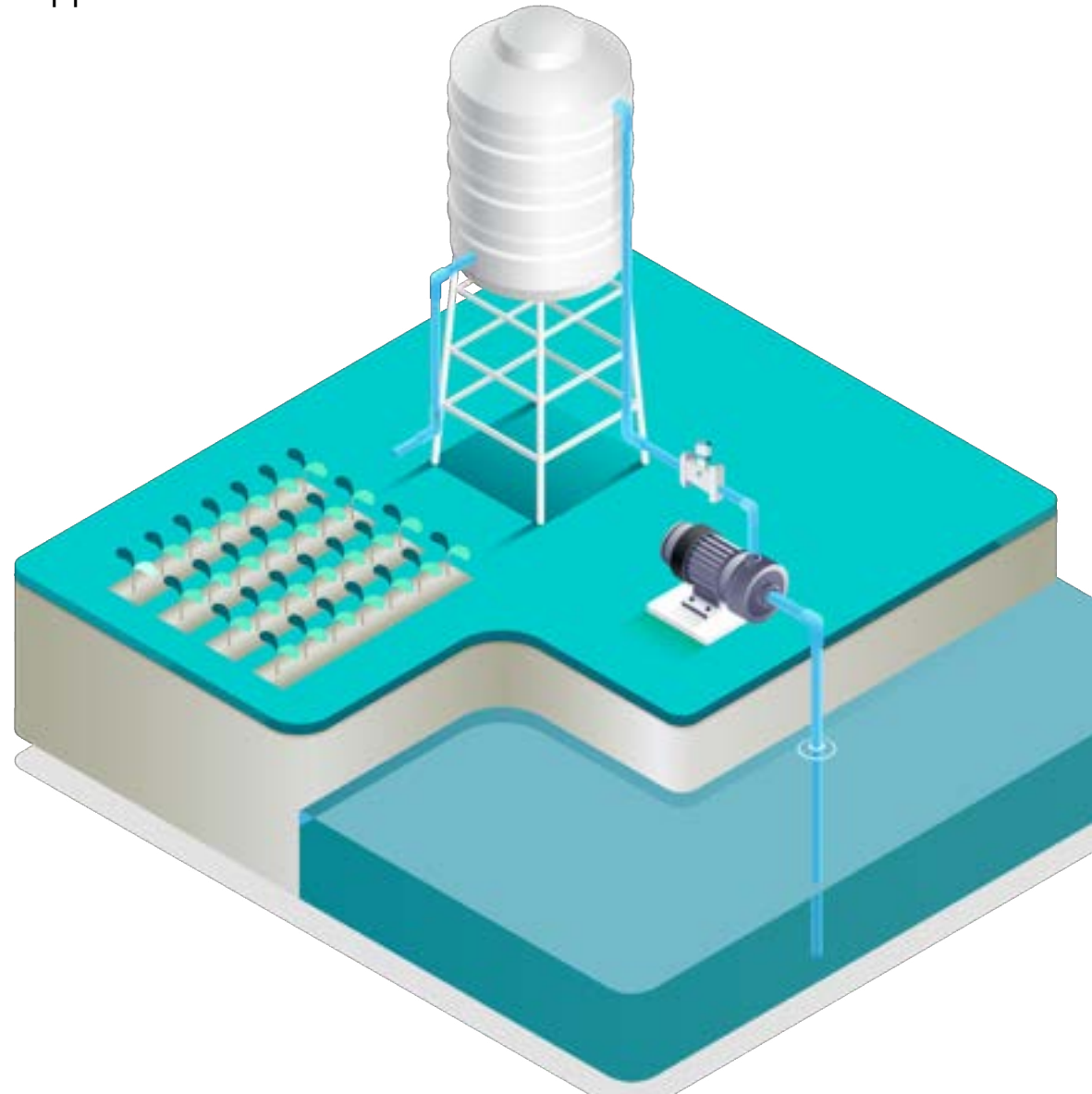

The robust SITRANS FM MAG 8000 operates in even the most challenging environments with consistently high accuracy and virtually no maintenance — making it a highly cost-efficient water metering solution.

High-precision water metering – no compromises necessary

Engineered for maximum flexibility without sacrificing accuracy, the SITRANS FM MAG 8000 is the ideal flow solution for a wide range of water applications, including abstraction, distribution, revenue and bulk metering, and irrigation. The MAG 8000 is available in both compact and remote versions with OD inlet/outlet requirements, making it easy to install virtually anywhere – even underground or in flood-prone locations. Its sturdy construction according to ISO 12944-2 is built to resist solids and other debris. And when powered by a highly efficient external lithium battery pack, the MAG 8000 can operate continually for up to 15 years in areas lacking mains power. An integrated power management program calculates the amount of power remaining, and a configurable “low battery” alarm alerts you when replacement is necessary.

Reliable and robust, it also features:

- Remote transmitter option with factory-mounted cables and connectors
- No moving parts resulting in less wear and tear
- Bidirectional accuracy
- Unrestricted flow tube for minimal pressure loss even at high flow rates
- IP68 / NEMA 6P enclosure and cable with coating corrosivity category according to ISO 12944-2 C4 or C5, allowing for sensor burial and operation in harsh conditions

Abstraction and distribution

To ensure that consumers receive a consistent supply of drinkable water, the MAG 8000 monitors all stages of network water flow from production plants and trunk lines to local delivery systems with:

- High accuracy - 0.2% to 0.4% of flow rate
- Bidirectional flow capability - one solution for all applications
- Network load monitoring - reduces leakage and saves energy
- Early leakage detection - achieved with reliable and repeatable measurements of low flow at night



Bulk water and revenue

To ensure water bills are fair, and to reduce the need for verification, the MAG8 000 CT measures usage precisely and cost effectively with:

- Custody transfer approval - according to international revenue standards OIML 49 and MI-001
- No moving parts - minimal maintenance requirements optimize your cost of ownership
- OD inlet/outlet - offers greater flexibility in meter installation

1
2
3



Irrigation

Where irrigation systems are used in crop production, the MAG 8000 keeps water wastage to a minimum and ensures that farmers get a fair deal with:

- No moving parts - not prone to wear and tear in the usual way
- IP68 / NEMA 6P enclosure - allows for installation in places where flooding can occur, or even complete underground burial
- Optional conduit adaptor - provides a clean, protected pathway for device cables to secure integrity in any conditions
- Battery power and easy connection to solar panels - ensures long-term performance in locations without reliable mains power



Intelligence at your fingertips

With comprehensive data collection and logging options, advanced diagnostic functions and the capability for remote monitoring and configuration, the SITRANS FM MAG 8000 keeps you fully in control of your water application – whether you're on-site or on-the-go.

Data flows better with Siemens

To enhance operational efficiency, improve billing accuracy and significantly reduce costs, the SITRANS FM MAG 8000 includes a built-in wireless automated meter reading (AMR) solution designed for use in Water Fixed Networks. Flow measurement data from any site can be accessed via a web browser and secure password protection.

The MAG 8000 also features a standard IrDA interface for configuration, data collection and documentation using SIMATIC Process Device Manager or Flow Tool software. For remote monitoring of water applications, an IIoT Wireless Communication Module can be added to log all data from the meter and send it to the IIoT Web Application in customizable intervals throughout the day. From there, the data can be further processed via email or ftp.



The 4G-based IIoT Wireless Communication Module collects measurement data from meters anywhere in the world covered by a LTE-M, NB-IoT or 2G network. Measurement data, parameters and alarms from the MAG 8000 are made accessible via the IIoT Web Application.

The MAG 8000 keeps you connected with:

The IIoT wireless communication module for SITRANS FM MAG 8000 is a communication system consisting of a hardware part combined with a web-hosted application for device management and measurement data transfer. The main features of the NB IoT module are to transmit periodically the flow readings from a MAG 8000 field device to an end user, real time notifications of alarms, online configuration, and remote diagnosis of the field device. Having all this done via a web application is significantly reducing the presence on site.

The IIoT wireless communication module is using the public mobile network as channel for transferring the measurement data to the MAG 8000 IIoT web application, where only authorized users have access to. In addition, the IIoT web application serves as an interface for the end user to provide the measurement data per Email or FTP.

Communication between the field device and web application runs over MQTT protocol, which is a widely used protocol in the IoT (Internet of Things) world.

- 2-channel analog input measurement for external ratiometric pressure transmitter, transmission together with flow measurement (2-in-1 solution)
- Real-time clock synchronization with internet NTP server, ensuring that all measurement data is accurately time-stamped
- Data transmission at customer-specified points in time, allowing for synchronization of information from multiple MAG 8000 devices
- Seamless communication via 4G(LTE-M / NB-IoT) and 2G networks.

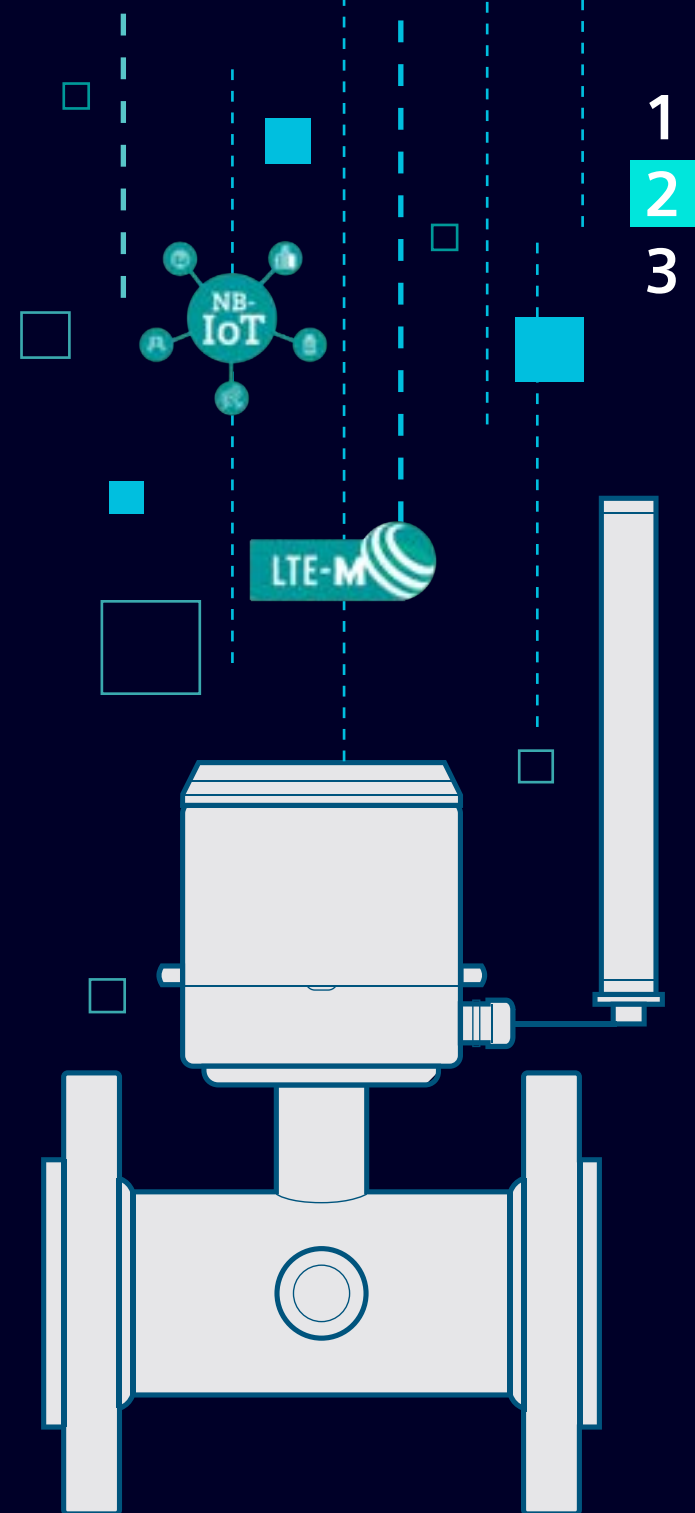

SITRANS FM MAG 8000

IIoT Wireless Communication Module

1
2
3

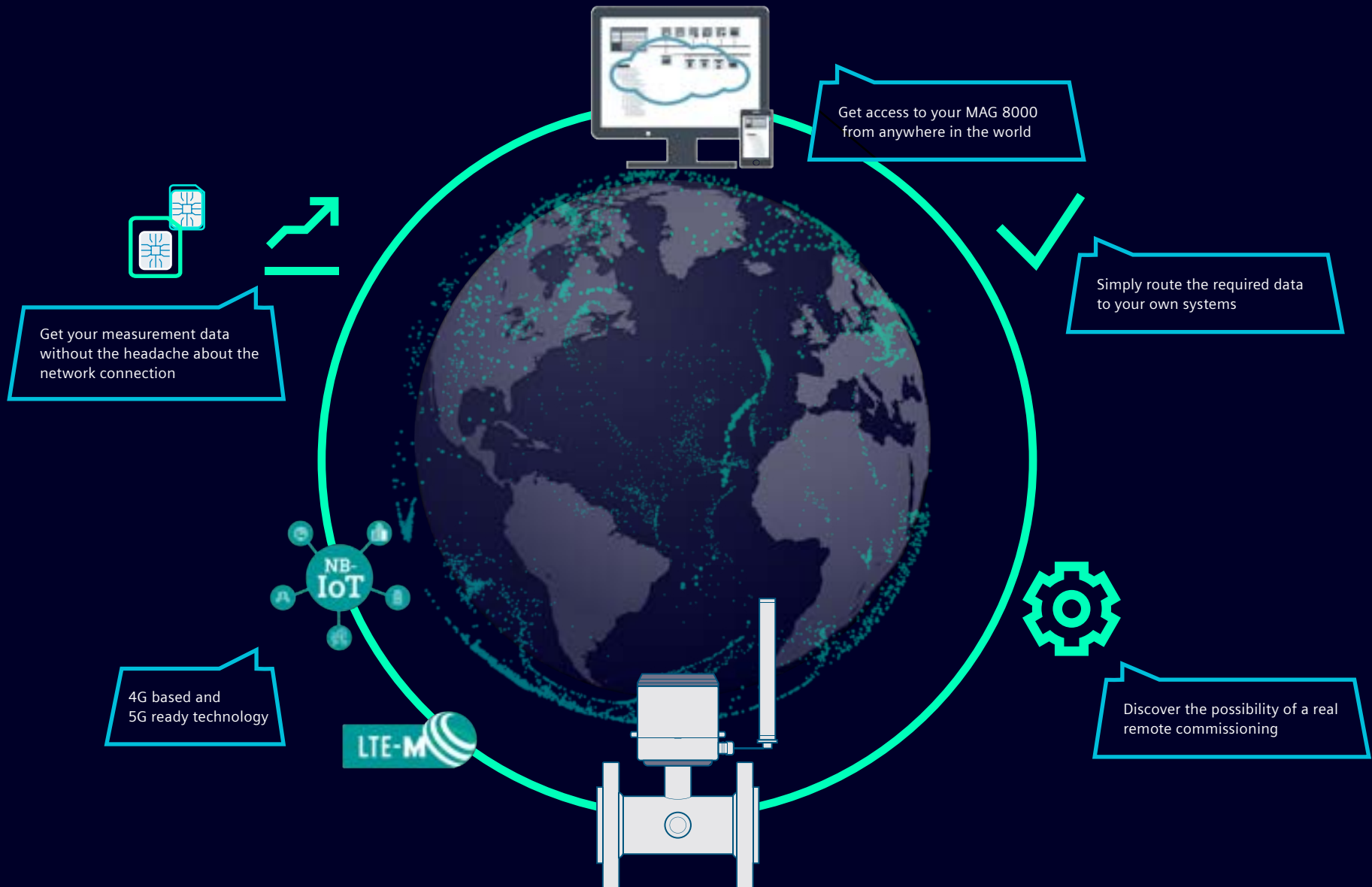

Once the MAG 8000 is installed, a wide range of smart features ensures reliable performance with minimal maintenance:

- An electrode resistance module measures the meter's contact with the media
- A product sizing program indicates whether the size of the meter selected is appropriate for the flow conditions on site
- A comprehensive data logging function records and stores consumption levels, alarms and operating conditions from the site
- Remote Qualification Certificate integrated into the IIoT Wireless Communication Module enables offsite quality audits on devices anywhere in the world

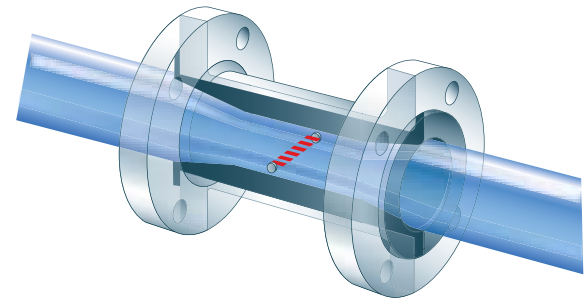

Improved low-flow performance
Siemens' conical flow tube design improves low-flow performance with negligible pressure drop across the meter for reduced energy loss.



Flow simulation
Integrated flow simulator verifies and adjusts the pulse output to any connected device or system, with configuration possible via the standard IrDA interface or the communication channel.



The free plug-in integrated into the SIMATIC PDM tool allows for on-site meter assessment and prints a Qualification Certificate for monitoring and auditing purposes.

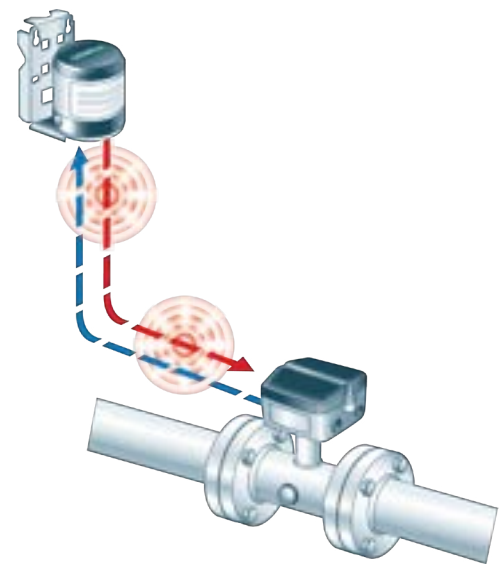

Insulation test
Built-in "cross-talk" test checks the entire signal chain of the system to ensure that the sensor flow signal is unaffected by external noise.

Accredited calibration for more accurate water measurement

Every Siemens water meter is calibrated in-house at facilities that are individually accredited in accordance with ISO / IEC 17025.

Flowmeter calibration is a vital step in ensuring consistently accurate measurement. All SITRANS FM electromagnetic meters are wet calibrated at Siemens flow facilities with traceable instruments referring directly to the physical unit of measurement according to the International System of Units (SI).

A certificate is supplied with every calibration to satisfy worldwide traceability standards, including NIST in the United States.

Siemens offers accredited calibrations assured to ISO/IEC 17025 in the flow range from 0.0001 to 10,000 m³/h.

Siemens Flow Instruments accredited laboratories are recognized by the International Laboratory Accreditation Corporation Mutual Recognition Arrangement (ILAC MRA), ensuring international acceptance of test results.



The robust SITRANS FM MAG 8000 operates in even the most challenging environments with consistently high accuracy and virtually no maintenance — making it a highly cost-efficient water metering solution.

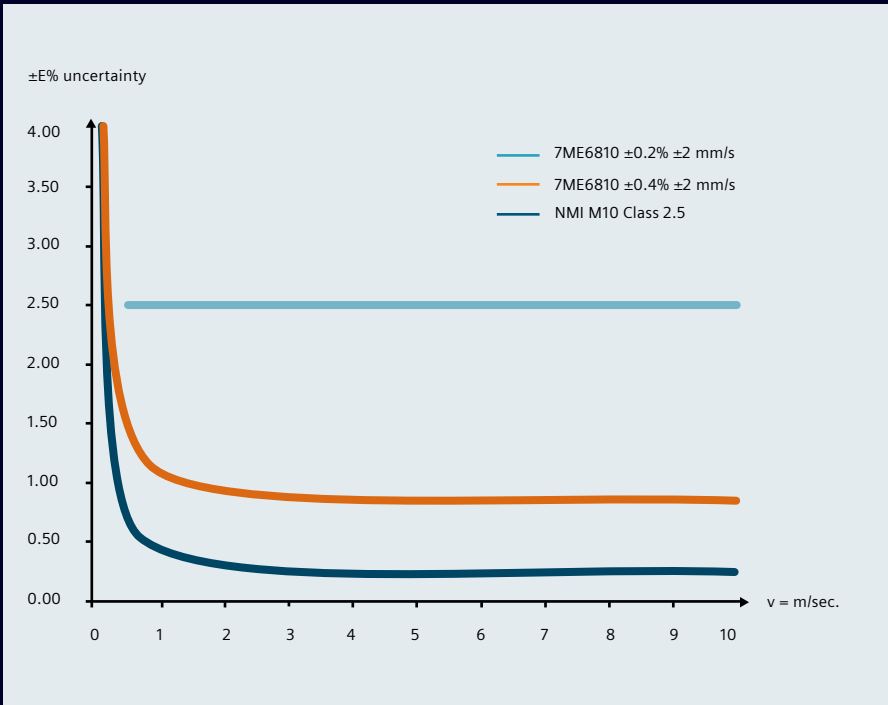

A calibration certificate is supplied with every water meter, and all calibration data is stored in the instrument.

SIEMENS CALIBRATION REPORT

SITRANS FM

Customer: _____
 Meter type: MAG8000 CT Serial No. 1013224543
 Meter type: MAG8000 DM10 Serial No. 1013224543
 RM Factor: 0.794245017
 System Serial No. 794245017

Calibration date: 05/10/2016 Calibration liquid: Water
 22.444.16 Calibration rig: Bery 1961.1
 20024 200

Calibration settings
 Frequency output: _____

Calibration results

Test No.	Q1 Flow (m³/h)	Water Temp. (°C)	True Flowrate (m³/h)		Parameter 1 Frequency output (Hz)		Parameter 2 Frequency output (Hz)	
			Q1	Q2	Q1	Q2	Q1	Q2
1	0.25	22.8	0.1768	0.1768	41.766	101.621	4.24	4.24
2	1.00	24.0	0.6877	0.6877	4.2862	1.0000	4.57	4.57
3	2.00	23.7	0.1889	0.1889	0.1889	0.0000	1.81	1.81

Calibrated by: Gross Date: 05/10/16 Approved by: _____ Date: _____

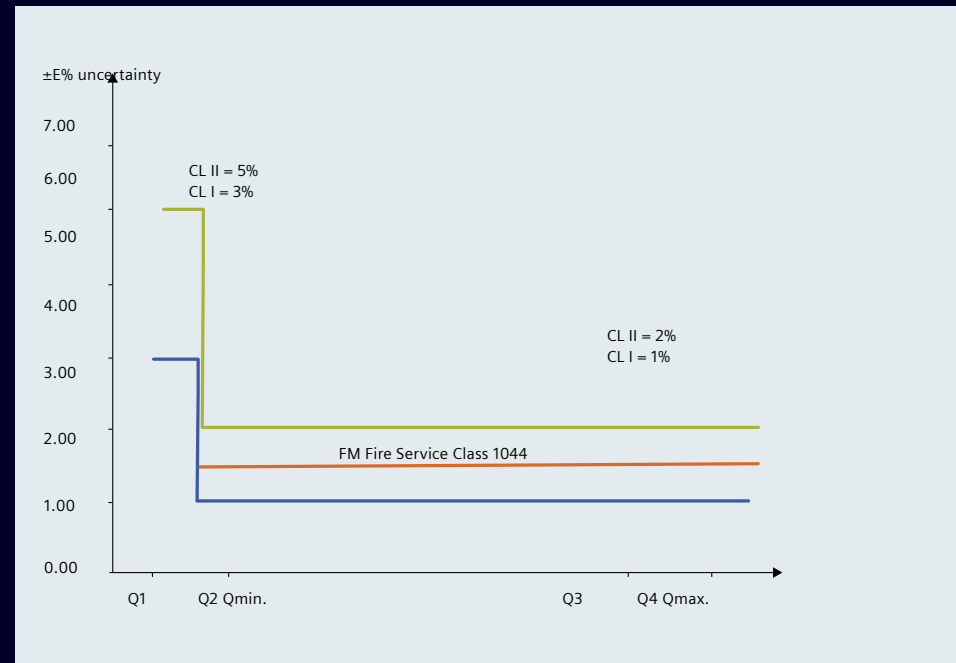

A suitable meter for every water application.

	MAG 8000 Standard	MAG 8000 CT
Application	Irrigation, abstraction and distribution networks	Bulk water and revenue
Transmitter type	Basic version Advanced version or advanced information and functionality	
Custody transfer version		Type-approved and verified according to OIML R 49 / MI-001
Sensor size DN	25 – 1200 mm / 1" – 48" with EPDM liner	Reflect mode with EPDM liner
Enclosure sensor and transmitter	IP68 / NEMA 6P, compact and remote with connectors and factory-mounted cable	
Display	Display with touch keypad	
Output	2 individual pulse outputs (forward, reverse and net volume)	
Communication	Integrated standard IrDA interface, IIoT Wireless Communication Module RS232 / RS485 with MODBUS RTU protocol, encoder interface module, with sensus protocol	
Power supply	Internal 2 D-cell or external 4 D-cell battery pack 12 – 24 V AC/DC and 115 – 230 V AC with battery backup	
Certifications	Approved to the international water meter standard OIML R 49/MI-001 (EU), complying with the European CEN – EN 14154, ISO 4064 specifications and FM Fire Service Class 1044	
Transmitter features	Data logger with configurable log interval up to 26 months, time and date, data protection, application identifier, alarm handling, meter status, diagnostics, battery power management, insulation test. Advanced version only (not valid for MAG 8000 I): Leakage detection, flow statistics and consumption profile, advanced diagnostics, self-check, meter utilization, tariff and settle date (revenue)	
Accuracy	±0.4% ±2 mm/s (DN 25 - 1200 / 1" – 48") ±0.2% ±2 mm/s (DN 50 - 300 / 2" – 12") NMI M 10 Class 2.5	OIML R 49 Class 1 and 2 MI-001 Class 2
Bi-directional measurement	Yes	
Process connections	ACS (France), WRc (UK), DVGW (Germany), NSF/ANSI Standard 61 (USA), Belgaqua (Belgium), KIWA and WRAS BS 6920 Cold Water (UK)	
Operating pressure	PN10/PN16/PN25/PN40	
Media temperature	0 – 70 °C / 32 – 158 °F	0.1 – 50 °C / 32 – 122 °F
Electrodes and earthing electrodes	Hastelloy C276	

Calibration type	Applications	Accuracy	Water meter type
Standard	General water	0.4%	MAG 8000 Standard
Extended	High-performance	0.2%	MAG 8000 Standard
Bulk water / revenue	Custody transfer (CT) FM fire service	OIML R49 Class 1 / Class 2 OIML R49 Class 1044	MAG 8000 CT



The accuracy of each meter is determined by the calibration performed. MAG 8000 water meters are available with three types of calibration, each suited to different application requirements.

SITRANS FM MAG 8000 IIoT

Wireless Communication Module

Digitalization use cases

From Asset Management to Complete solutions

SITRANS IQ Suite



SIWA Suite

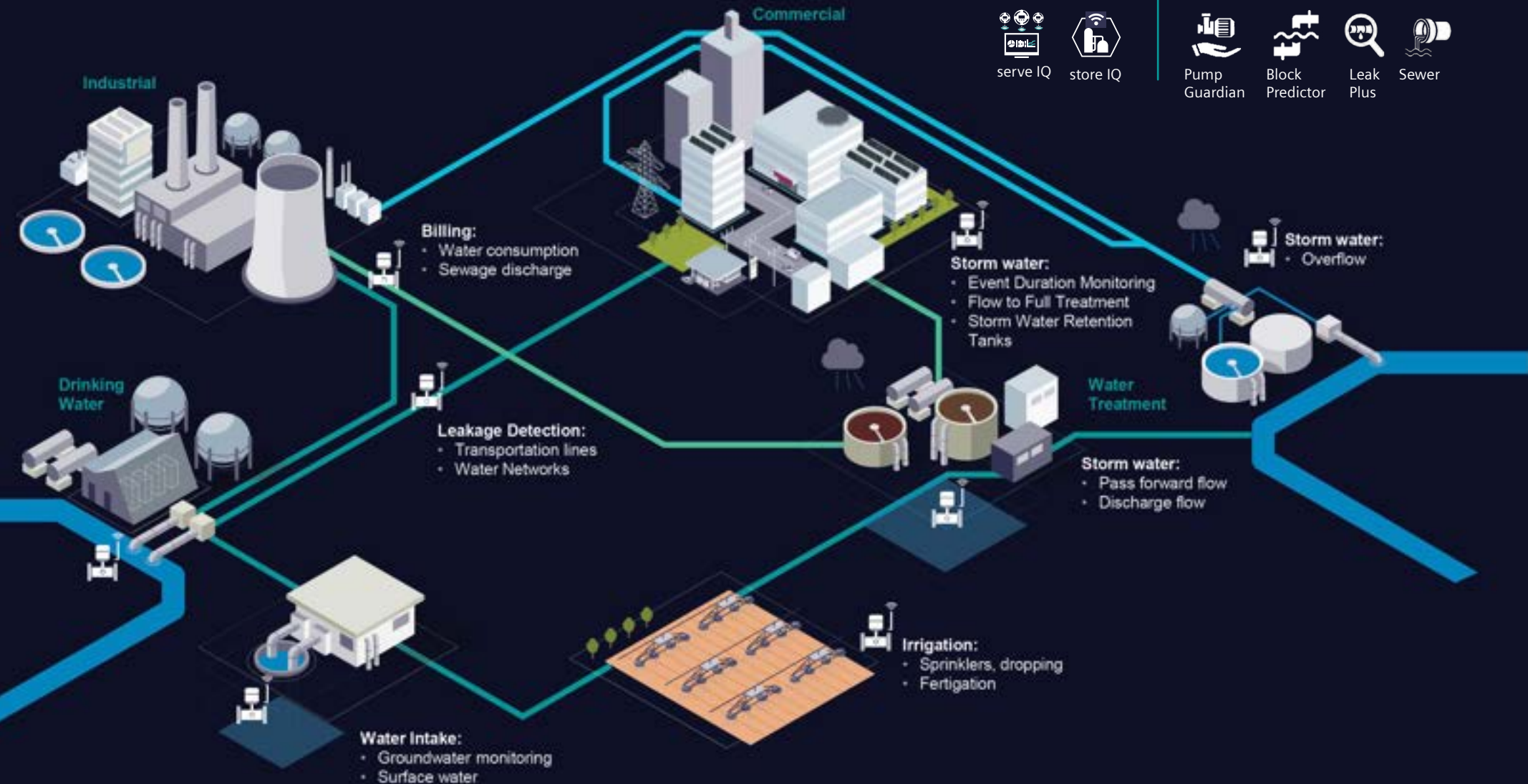

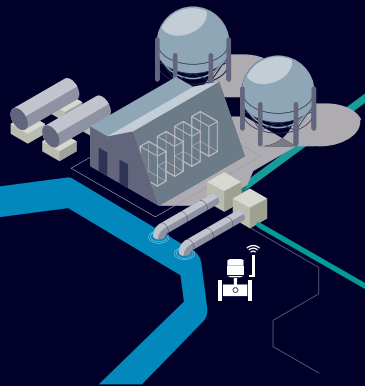

Drinking Water

Our easy-to-install Smart Water Meter allows our customers to monitor water abstraction, monitor the network and detect leaks, all without the need for an external power supply.

Remote communication improves the reporting capabilities of water utilities, no matter how far away, and provides all relevant information about water sources and network profiles that help avoid overuse of ground wells, lakes or others.

Digitalization makes this data a valuable asset through a seamless integration solution for quick reporting with SITRANS serve IQ. For advanced leakage detection and location in large extension areas or complex configurations-our SIWA Suit is the best choice.



Industrial

Accurate and certified measurements meeting international Custody Transfer standards for billing purposes is one growing trend as major industries have to report their water consumption.

SITRANS FM MAG 8000 with IIoT technology simplifies the traditional data reading carried out when visiting the site.

Remote data reporting reduces transportation times contributing directly to impacting the carbon footprint for a better world.

Another benefit is daily reporting with all details on consumption profiles that allow water companies to improve water supply in a smart way using the 24h trend reporting and reducing OPEX during the daily operation and enabling customers to get more detailed reports.



Commercial

Smart water meters are also getting used more on commercial applications bringing advantages to both water supplier and users to get a clear visibility on consumption patterns and also avoid leakages in commercial centers, hospitals and government offices.

Our MAG 8000 with IIoT technology also fits in this new area, providing diverse digital ways to report information and receive in real time notifications to indicate problems. In the installation point SITRANS serve IQ enables an alarm to be set for high or low levels that allow water companies to react under certain conditions, saving time and millions of liters of water.

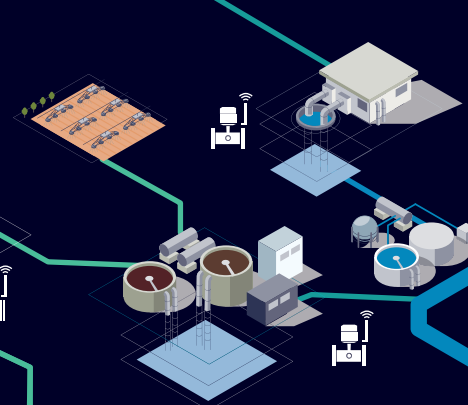

Water Treatment

The need to report sewage water coming from industrial and commercial areas is a new way to plan the water treatment plant load, and also learn the discharge patterns that will allow water companies to improve and use in a better way the infrastructure available. For that purpose we have a large selection of digitalization solution in our SIWA Suite, such as Pump Guardian, Block Predictor and Sewer in combination with our SITRANS store IQ App.

Water reuse and rain water collection is a new sustainable way to help to mitigate the water needs for Irrigation or Industrial water as a reliable alternative for a better future. With our solutions we can provide all data needed to complete the water cycle and better utilize this precious resource, giving it a second chance.

1
2
3

Published by

Siemens AG

Digital Industries
Process Automation
Östliche Rheinbrückenstr. 50
76187 Karlsruhe, Germany

Article No.: DIPA-B10289-00-7600

Printed in Germany

© Siemens 2022

Only available as PDF

Subject to changes and errors. The information provided in this brochure contains descriptions or performance characteristics which, in case of actual use, do not always apply as described or which may change as a result of further development of the products. The desired performance characteristics are only binding if expressly agreed in the contract. Availability and technical specifications are subject to change without notice.

All product designations may be trademarks or product names of Siemens AG or supplier companies, the use of which by third parties for their own purposes may violate the rights of the owners.